



## THE IMPACT OF DISPOSAL AND TREATMENT OF COAL MINING WASTES ON ENVIRONMENT AND FARMLAND

Zhengfu BIAN, Hui WANG, Shouguo MU, Hailong LENG

ID 027

China University of Mining and Technology, Institute of Land Resources  
Xuzhou, Jiangsu Province, CHINA

[zfbian@126.com](mailto:zfbian@126.com)

### ABSTRACT

Coal mining wastes is traditionally dumped as a cone-shaped tip in China, which will pollute air, soil and water environment and landscape by dust, leachate, self-ignition and no vegetable cover. Since 1980s, the technique for coal mining wastes disposal has been changing into transporting them directly to fill subsided land for reuse of subsidence land. And now coal mining wastes dump and filling subsided lands are in existence simultaneously. However, the impact of different disposal and treatment of coal mining wastes on environment and farmland has not been probed in detail. Taking Dongtan (DT), Nantun (NT) and Xinglongzhuang (XLZ) Coal Mines as examples, the components of coal mining wastes and their potential pollution on soil, surface water and ground water are tested in-situ. The results show that contaminants are released after self-ignition and weathering of coal mining wastes, but they are not super the allowance of environmental standards. Even though, we must pay more attention to the transportation and accumulation of these contaminants.

**Key words:** mining wastes, environmental impact assessment, green mining, reclamation.

\*Supported by the 111 Project (Project No.B07028)

### INTRODUCTION

The mining and utilization of coal may cause environmental impacts in different ways. The emissions of CO<sub>2</sub> and other poisonous gas from coal burning have been paid more and more attention recently. In adverse side, the environmental problems due to coal mining were neglected by mine owners and our society. In fact, coal mining has drastically adverse environmental impacts, including interference with ground water, land subsidence, impact of water use on flows of rivers and consequential impact on other land-uses, mining wastes disposal, geological hazards, visible and aesthetic offenders, sometimes damaging infrastructure, and potential ecological havoc (Bell, 2000; McKinnon, 2002; Earle & Robert 1996; Sengupta, 1993; Bian, 2006), among of which mining wastes disposal has less progress considering disposal methods, utilization of mining wastes and its impact on environment. Since around 1800 coal became the main energy source for the industrial revolution and Britain developed the main techniques of underground mining from the late

18th century onward with further progress being driven by 19th and early 20th century progress, coal mining wastes have been transported into dump to fill a gully or tip as a hill.

Waste products from coal mining comprise coarse discard (minestone) and fines produced by the washing process. The former comes to the surface, mostly with 'run of mine' coal as a result of the cutting of roadways, drivages, other underground development work and the high degree of automation applied to variable geology. While the coalfield operator does not seek to produce waste unnecessarily, geology and mining methods combine to add to the quantities involved. Theoretically mining methods could be made more sustainable by minimising the production of waste. It is the need to accommodate both dry minestone and 'wet' fines which imposes the main engineering constraints on tip design and controls the pace of progressive restoration. Though waste reduction and reuse have recently become the most preferable methods in waste management, for example, minestone has been accepted in many places as alternative aggregates in embankment, road, pavement, foundation and building construction, lots of coal mining wastes have still been transported into dump to fill a gully or tip as a hill. This paper introduces the situation of coal mining wastes disposal in China, the results of investigation of the impact of mining wastes on the environment and farmland in Yanzhou coalfield and proposes two innovative ways for mining wastes disposal.

## **THE SITUATION OF COAL MINING WASTES DISPOSAL IN CHINA**

### **The production of coal mining wastes**

China is the world's largest coal producer and consumer with production of raw coal 2.21 billion tons in 2006 and the share of coal in total energy production in China is over 70%. 95% of total coal production is from underground coal mines. The average production of coal mining wastes is about 15% of coal production, which varies from 10% to 30% with the change of geological and mining conditions. Therefore, it is estimated that the annual production of coal mining wastes is about 315 million tons for underground coal mining after 2005, which accounts for a quarter of total industrial solid wastes. There are about 4.5 billion tons coal mining wastes stockpiled at 1700 waste dumps which occupied 15 thousand hectares lands and about 200 dumps self-igniting. According to the latest statistic data, the rate of raw coal washing is about 35% and the rate of separating undesirable materials from coal is about 15%, so there are about additional 116 million tons mining wastes produced by the washing process.

### **The reclamation, treatment and utilization of coal mining wastes in China**

Since P. R. China founded in 1949, Chinese coal mines have been constructed after the pattern of former Soviet Union with the mining wastes being transported into dump to fill a gully or tip as a hill. Till the end of 1970s, a research and pilot project was carried out in Huaibei coal mining area, Anhui Province in which the minestone from underground mining was transported to fill and reclaim subsidence lands. Almost at the same period, the

comprehensive utilization of coal mining wastes as construction material and fueling power plant was widely the rage. Now the average percentage of mining wastes treatment, utilization and reclamation is about 42%, which varies from 20% to 73% with the change of resources condition in different regions and the amount of different uses is shown as figure 1. Suppose the average rate of utilization of coal mining wastes reached 50%, 25% of them were used as fills in 2006, there were 215.5 million tons coal mining wastes being dumped and 107.75 million tons coal mining wastes were used as fills which would exist potential pollution to soil and ground water. Besides the utilization and treatment of coal mining wastes above stated, since 1980s, some abandoned mining wastes dumps also have been reshaped and planted in China.

### The main environmental problems from coal mining wastes dump

As stated above, majority of coal mining wastes in China was dumped as a cone-shaped heap shown as figure 2 (left), which had potential slope failure and a series of environmental problems. The various failure modes that occur in mine waste embankments have been summarized by Caldwell and Moss (1981) who review the methods of analysis. But the situation of self-igniting mining wastes dump and the effect of water and plant growth on slope stability have not been considered. On May 15, 2005, mining wastes dump of No. 4 coal mine of Pingdingshan coal mining company exploded because of inner vapor pressure accumulation after it rained continuously, which resulted in 8 local residents died, 123 peoples hurt and 18 residents house buried. Besides the slope failure and explosion, following environmental problems from mining wastes dump are also involved:

- 1) slope stability and erosion;
- 2) occupation of lands;
- 3) potential contaminants leachability into ground water;
- 4) dust pollution by wind, air pollution and explosion by self-igniting;
- 5) visual and landscape impacts and landuse constraints.

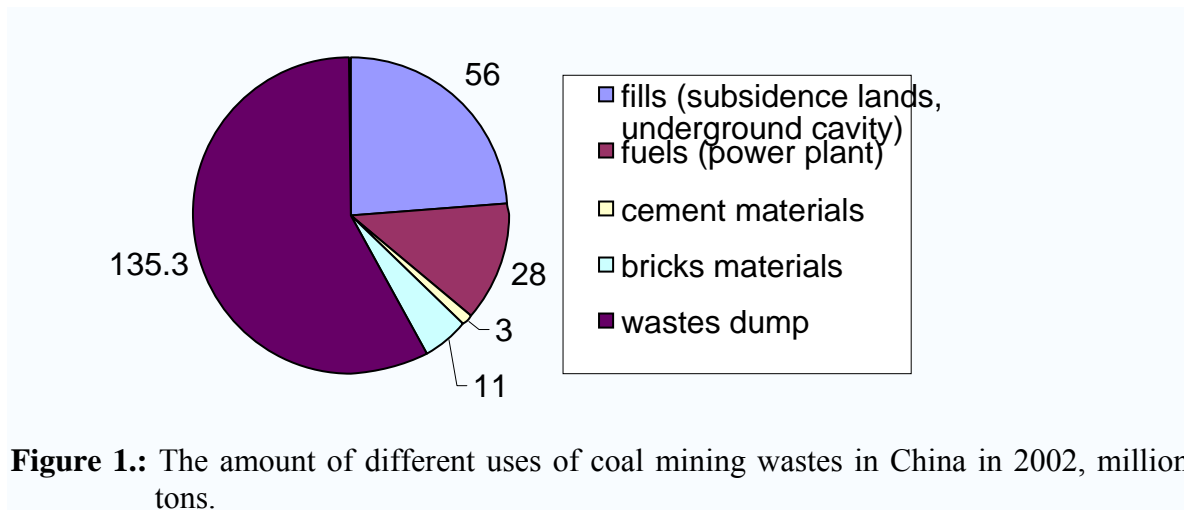

**Figure 1.:** The amount of different uses of coal mining wastes in China in 2002, million tons.

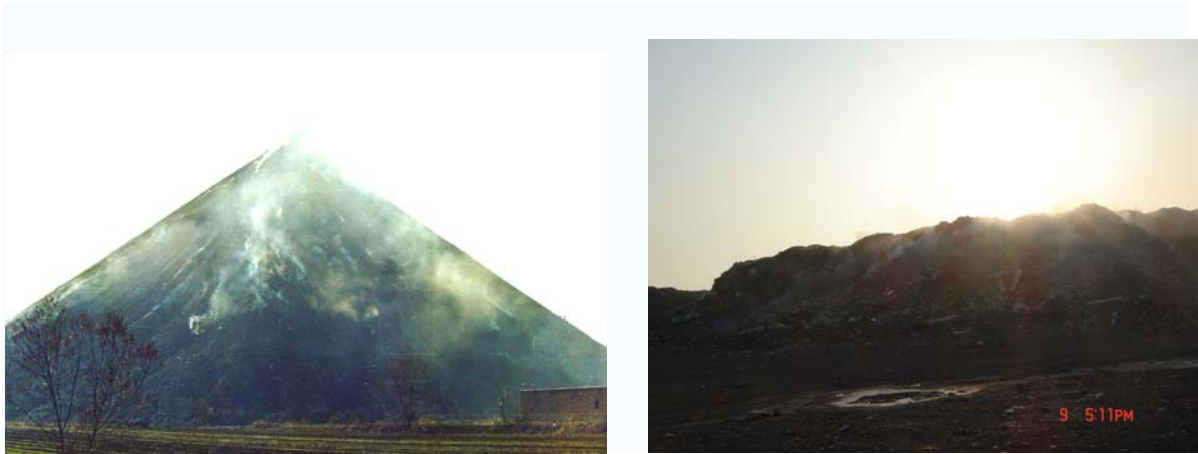

**Figure 2.:** Cone-shaped mining wastes heaps being self-igniting.

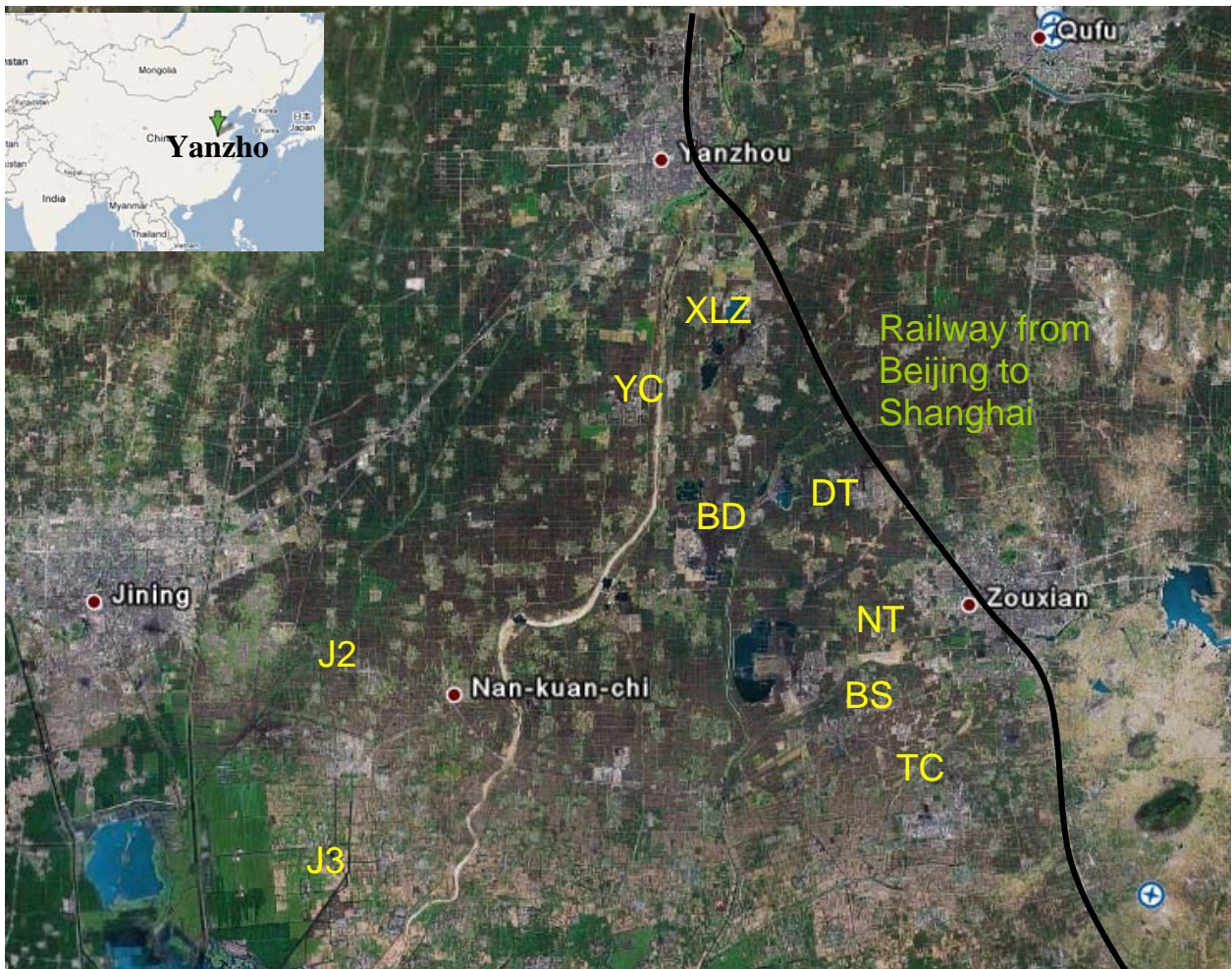

**Figure 3.:** The location of Yanzhou coalfield

XLZ, YC, BD, DT, NT, BS, TC, J2, J3 represent Xinlongzhuang, Yangcun, Baodian, Dongtan, Nantun, Beisu, Tangcun, Jining No.2 and Jing No.3 coal mines respectively.

## **THE IMPACT OF MINING WASTES ON THE ENVIRONMENT AND FARMLAND IN YANZHOU COALFIELD**

### **Physical condition of Yanzhou Coal Mining Company**

Yanzhou coalfield is located in the south of Shandong Province, which is of typical features of east China plain mining with subsidence flooded lands and dense villages in mining areas and with 444.2km<sup>2</sup> of mining area. The headquarter of Yanzhou Coal Mining Company founded in 1976 is at Zoucheng city, which is passed by railway of Beijing to Shanghai. The total raw coal production reached 34.66 million tons produced by NT, XLZ, BD, DT, BS, YC, TC, J2 and J3 coal mine. The annual average temperature is about 14.1°C and average precipitation is about 712.99mm.

### **The situation of coal mining wastes disposal at Yanzhou coal mining area**

The total raw coal production produced by Yanzhou Coal Mining Company from 1977 to 2005 is 461.58 million tons. If we calculate the production of mining waste in terms of the rate of 15% of coal production, it would be 69.24 million tons. In fact, there are only 15.51 million tons wastes piled and occupied 28.44 hectares land in disorder. Majority of mining wastes were utilized as fills for subsided land reclamation and road construction and, a small proportion about less 10% was used as construction materials to make bricks, fuel for power plant. Now there are 9 mining wastes' dumps in Yanzhou coalfield, among of which two were reshaped and planted as a recreational site. Therefore, we can find whatever coal mining wastes have been used for, their potential pollution should be considered, especially when they were used for fills they may pollute ground water and soil.

### **The impact of cone-shaped mining wastes dump on environment**

If coal mining wastes were tipped as a cone-shaped heap being naked, dust and leachability will affect soil and surface water in Yanzhou coalfield.

#### ***Soil pollution investigation***

Dust from mining waste dump does not only affect human health, but contaminate the adjacent soil also. We made a field investigation on its impact on the soil.

Investigation site is a mining wastes dump of Dongtan Coal Mine with 45m of height and 27550m<sup>2</sup> of area. The dominant wind direction is from Southeast to Northwest. From the north edge of mining wastes dump, we took a soil sample every 30m along the wind direction and every sample was obtained by mixture of soil of three points with the same distance from the edge of mining wastes and every sample was separated in different depth of 20cm, 40cm, 60cm.

The results of soil sample analysis are as table 1, which can be illustrated as figure 4.

**Table 1.:** Soil sample analysis (mg/kg)

Sample	Distance m	Depth cm	pH	Cu	Pb	Cd	Cr (total)	Zn
1	30	20	8.0	38.0	19.5	0.051	38.85	75.0
		40	8.3	33.3	22.8	0.030	43.55	76.6
		60	8.2	30.1	17.4	0.033	44.85	76.6
2	60	20	8.0	30.8	19.2	0.045	43.15	81.0
		40	7.7	21.7	27.7	0.030	32.90	67.8
		60	7.9	21.3	23.1	0.019	24.15	87.4
3	90	20	7.8	24.9	34.5	0.057	46.30	91.2
		40	8.0	23.1	19.5	0.056	37.60	77.4
		60	7.3	60.4	21.4	0.034	47.15	69.6
4	120	20	7.0	52.8	22.4	0.041	43.80	72.6
		40	7.0	25.3	27.7	0.049	43.40	80.2
		60	7.1	61.0	20.9	0.055	50.65	79.0
5	150	20	7.0	34.3	19.1	0.048	40.05	86.4
		40	7.3	20.8	22.8	0.048	60.10	79.0
		60	7.5	30.4	21.7	0.041	67.20	78.6
6	180	20	7.0	35.6	22.0	0.057	64.70	83.0
		40	7.0	23.6	24.8	0.034	67.20	79.8
		60	7.2	34.1	32.1	0.036	71.60	75.0

Note: pH was tested by the ratio of water to soil being 1∥ 1. Sampling date: August 8, 2006

From table 1 and figure 4, we can find that: 1) the closer distance, the higher pH; 2) As for the depth of 20cm, the maximum of Zn, Cd, Pb, occurs at a distance of 90m, the maximum of Cu appears at a distance of 120m, and the maximum of Cr also appears at a distance of 90m if we exclude the last sample with a distance of 180m; 3) As for the depth of 40cm, the maximum of Cd occurs at a distance of 90m, the maximum of Pb appears in two samples of 60m and 120m, the maximum of Zn appears at a distance of 120m, and the maximum of Cu also appears at a distance of 120m if we exclude the first sample with a distance of 30m, the value of Cr is in disorder; 4) As for the depth of 60cm, the maximum of Cd, Cu appears at a distance of 120m, the maximum of Zn appears at a distance of 60m, and the maximum of Pb also appears at a distance of 60m is we conclude the last sample with a distance of 120m, the value of Cr is still in disorder. Considering the effect of dust mainly on surface soil, we can conclude the maximum of main contaminants appear at a distance of 90m which is about twice of the height of mining wastes' heap.

### *Surface water pollution investigation*

Lixiviation experiments were conducted, by which mining wastes were soaked in the liquid of pH 7 and soaking time was 24h and 96h. The results of the experiment are as table 2.

**Table 2.:** The results of lixiviation experiments on mining wastes (mg/L)

Site	Soaking time	Cu	Pb	Cd	Cr T	Zn	pH
NT	24h	0.050	0.256	0.002	0.797	0.519	7.7
NT	96h	0.057	0.331	0.002	0.909	0.643	7.7
DT	24h	0.104	0.296	0.0025	0.837	0.452	9.2
DT	96h	0.276	0.476	0.0025	0.975	0.658	9.3

By lixiviation experiments, we found pH and heavy metal concentration of mining wastes at DT site are higher than those at NT site. In fact, the results are relevant to the time of weathering of mining wastes, the longer of weathering time, the lower pH. Compared with “the Pollution Control State Standards for Storing, Treatment Site of General Industrial Solid Wastes” GB18599-2001, the concentration of heavy metal of lixiviation water of mining wastes is not over standards, but the pH at DT site is a little bit high.

Field sampling of water leaching from mining wastes dumps of NT and DT coal mines also was taken. The results of field sampling water test are as table 3, which is in accordance with lixiviation experiments.

**Table 3.:** Leaching water from mining wastes dump (mg/l)

Site	Cu	Pb	Cd	Total Cr	Zn	pH
NT	0.051	0.087	—	0.441	0.318	7.5
DT	0.187	0.098	—	0.672	0.327	8.4

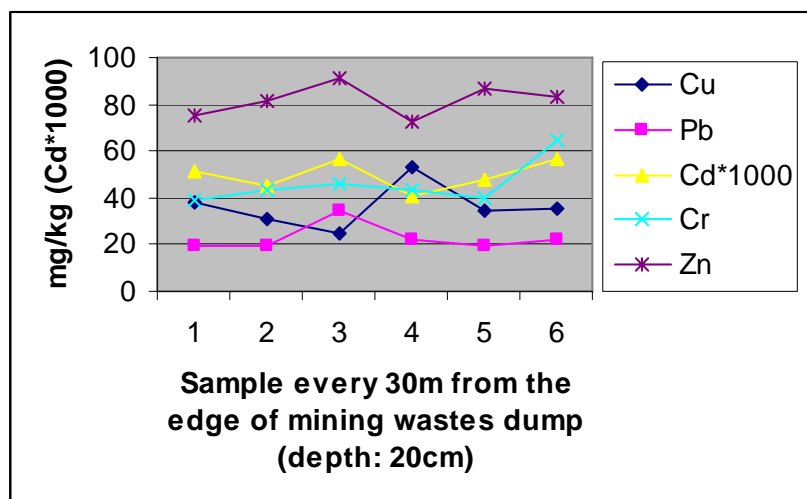

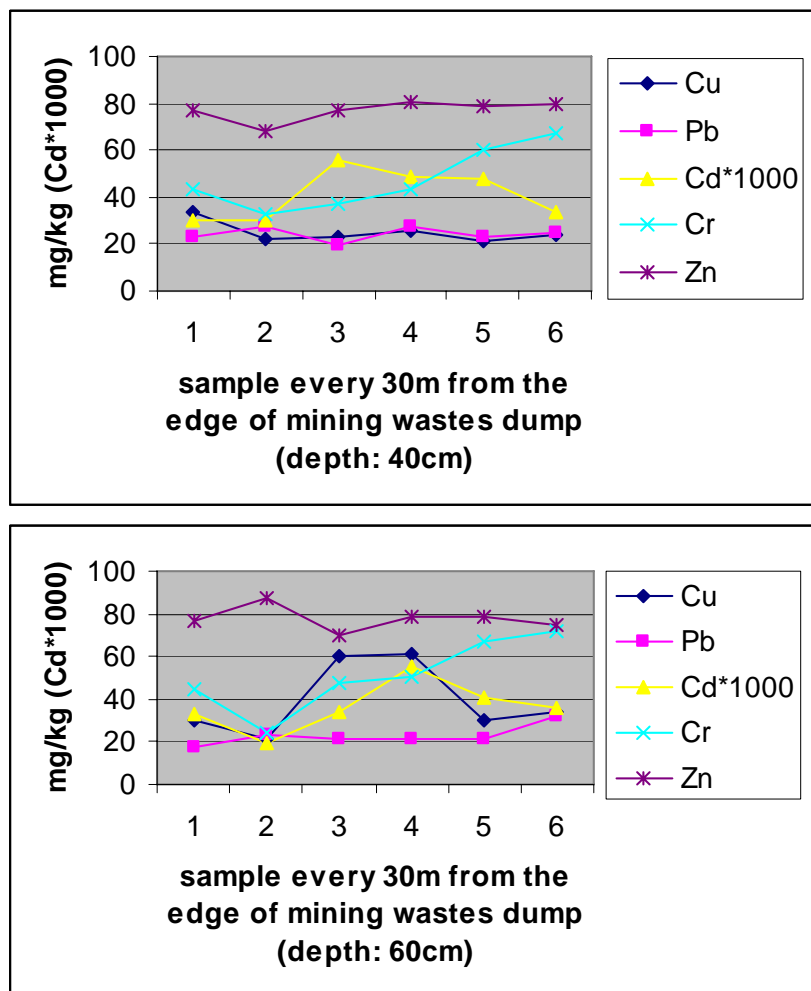

**Figure 4.:** Soil contamination by dust from mining wastes dump.

### *Ground water pollution investigation*

To investigate whether ground water is polluted by mining wastes, 5 sites at XLZ coal mine were monitored which locations are shown as table 4. The monitoring results are as table 5.

**Table 4.:** Monitoring sites

site	location	Monitoring purpose	Direction in terms of subsidence basin	The distance from subsidence basin
1	South side of mining wastes dump	Ground water underneath the dump	Southeast	100m
2	Power plant water well	Deep ground water	Southeast	150m
3	Subsidence basin	Water in subsidence basin	—	—
4	West ventilation	Downstream of	West	660m



5	shaft Sizhuting water well	ground water Downstream of ground water	Northwest	793m
---	----------------------------------	---	-----------	------

**Table 5.:** Monitoring results (mg/L)

site	pH	Cd	Pb	Ni	hexad Cr	cyanide	chloride	sulphate	TR
1	7.44	—	—	—	—	—	103	145	466
2	7.39	—	—	—	—	—	113	88	453
3	7.45	—	—	—	—	—	110	69	449
4	7.18	—	0.001	—	—	—	46	48	470
5	7.35	—	—	—	—	—	38	113	488

Site	PI	fluoride	As	Hg	Coliform individual/L	Temperatur e ° ° °	Water table m	Depth of water well m
1	0.68	0.49	—	—	27	16	7.2	40
2	0.69	0.5	—	—	11	16	40	140
3	0.72	0.37	—	—	38	16	3.2	40
4	0.74		—	—	24		7.4	48
5	0.73	0.33 0.39	—	—	27	16	6.3	40

Note: 1) PI, permanganate index; 2) TR, Total rigidity, counted by calcium carbonate; 3) The lowest for workout: cyanide with 0.004mg/L, Pb with 0.5µg/L, Cd with 0.5µg/L, hexax Cr with 0.004mg/L, Ni with 1µg/L, As with 0.01 mg/L, hg with 0.05µg/L; 4) “—” represents not founding the test.

**Table 6.:** Standards for Drinking Water Quality, GB 5749—2006 mg/L

pollutants	pH	Cd	Pb	Ni	Hexax Cr	cyanide	chloride
Standards	6.5-8.5	≤0.005	≤0.01	≤0.02	≤0.05	≤0.05	≤250
pollutants	sulphate	TR	PI	fluoride	As	Hg	coliform
Standards	≤250	≤450	≤3.0	≤1.0	≤0.01	≤0.001	forbid

Compared with Standards for Drinking Water Quality shown as table 6, two pollutants, TR and coliform of the ground water from 5 sites are super the standards. Because coliform is a biological index, mining wastes is not the source of coliform, which must be from other sources. TR is a little bit higher than the standard, and the TR of the ground water just underneath the subsidence basin is not super the standard. Therefore, we can conclude that mining wastes have few effect on ground water.

### The main effects of mining wastes on environment in Yanzhou coalfield

After excluding the effect of mining wastes on surface water and ground water, we can conclude that the main effects of mining wastes on environment in Yanzhou coalfield will

be dust pollution, air pollution from self-igniting, visual impacts and potential slope failure of mining cone-shaped wastes dump.

## **THE WAYS TO ELIMINATE THE EFFECTS OF MINING WASTES ON ENVIRONMENT IN YANZHOU COALFIELD**

### **Tipping mining wastes for landscape construction**

Yanzhou Coal Mining Company recognized that mining wastes are by-product of coal mining, which can not be fully used as resources or fills for reclamation and some of which must be tipped to a cone-shaped dump for land saving. To alleviate the impacts of mining wastes dump on the environment, our institute was requested to develop a technique to rehabilitate mining wastes dump and construct recreational site while mining wastes were tipping at J3 coal mine by Yanzhou Coal Mining Company.

The main problems involved into such request are slope stability, especially after covering soil and planting trees and shrubs on the slope, demands for recreational purpose from aesthetics and the limited space for tipping enough mining wastes.

By means of geotechnical theory and the model of critical balance, when  $H_1=9\text{m}$ ,  $H_2=5\text{m}$ ,  $H_3=4\text{m}$ ,  $:1m_1=3 :1$  (or 2.5),  $:1m_2=2.5 :1$  and  $:1m_3=2 :1$  shown as figure 6, we can keep the safe coefficient of slope stability more than 2.0.

To meet the demands for recreational purpose, the road up to the peak of dump was set up when we designed the mining wastes dump, which can be used for transporting the wastes and materials during tipping mining wastes and constructing the landscape and after wastes tipping stop, the road can be used for sightseeing, which width is 6 m, and the slope is less  $5^\circ$ .

The rational drainage system on the dump is a effective measures for slope stability. The ditches of drainage system fall into three classes, the first class is set up around each step, and the second is set up at the side of road, which is up to the peak, the third is built around the hill at the foot of dump. The rainfall from the dump flows from each step to the second ditch, and then into the third ditch.

After tipping mining wastes 50 cm thickness with its water content 7-11%, mining wastes dump was pressed by road roller. The index to examine the effectiveness of compaction is the change of elevation. In general, when it is less than 5 mm, we can determine the compaction is satisfactory.

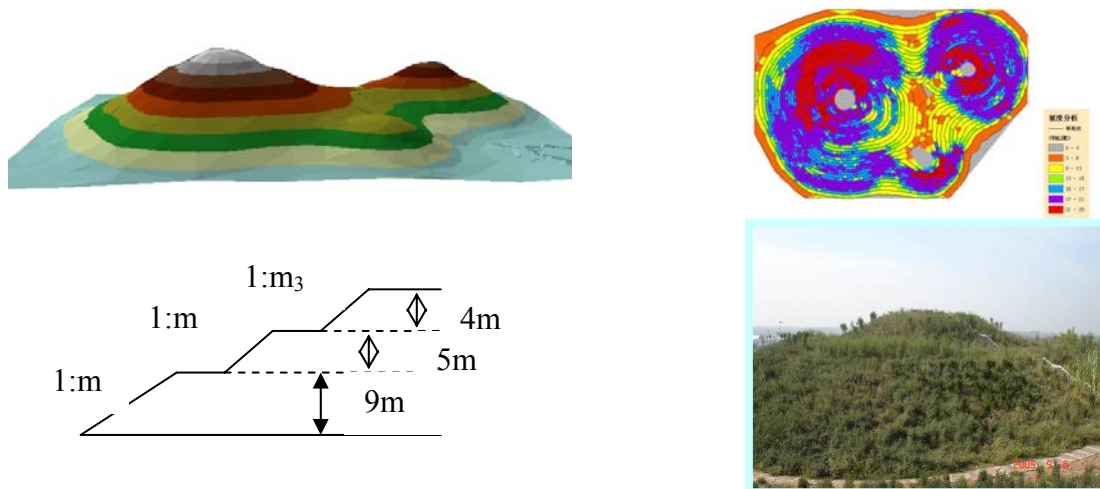
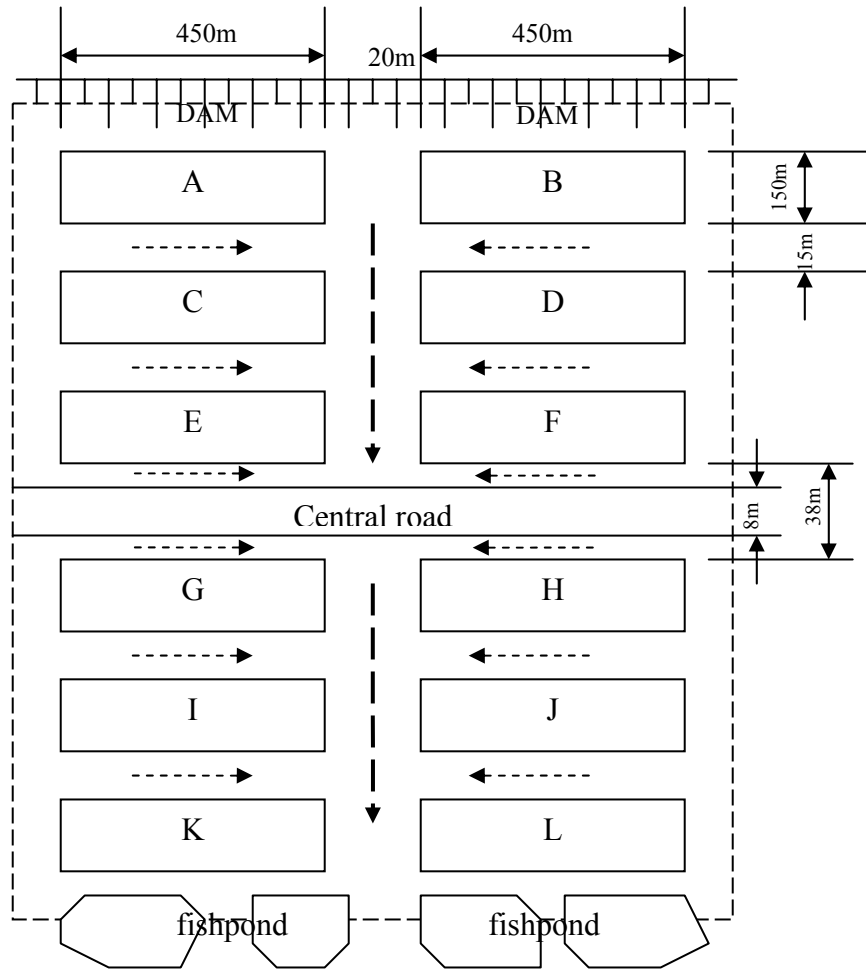

**Figure 5.:** Rehabilitate mining wastes dump and construct recreational site while mining wastes at J3 coal mine.

### **Filling mining wastes into subsidence basin to reclaim lands for different purposes**

In coal mining area, because of land subsidence, there are only few cultivated lands to be left at some towns and villages, therefore there are strong demands for local farmers to reclaim subsidence lands for agricultural purpose. How to reclaim flooded subsidence lands duo to mining for croplands is an important technical problems to be solved. In past 15 years, cultivated lands decreased 426.8 hectares and flooded lands increased 372 hectares due to coal mining by DongTan Coal Mine for Zhongxin town of Zoucheng city. The elevation of farmland before mining is from +43.4 to +45.6m with an average +44.50m. Coal mining resulted in maximum subsidence about 4.5m and the depth of flooded water about 0.5m. To fulfill the targets of overall land use planning, which ensure the area of farmlands will not decrease in the period of planning term, coal mine must provide fund and technologies to reclaim subsidence lands into cropland.

The distance from coal mining wastes dump to subsidence lands to be reclaimed is only 1000m. After optimized, the technique of filling mining wastes into subsidence basin for reclaiming lands is selected. The shop drawing is as figure 6. The working sequence was as followings, taking humus soil out from plot A and plot B for constructing dam on the north side of plot A and plot B and then filling mining wastes into plot A and plot B; taking humus soil out from plot C and plot D for covering plot A and Plot B and then filling mining wastes into plot C and plot D; the rest may be deduced by analogy till plot K and plot L which can be covered by humus soil from adjacent subsidence lands which were reclaimed as fishponds. By employing filling method, 2 million tons mining wastes can be used as fills and 81 hectares lands were reclaimed for croplands.



**Figure 6.:** Drawing for subsidence land reclamation by filling mining wastes.



**Figure 7.:** Subsidence lands before reclamation and after reclamation at Dongtan Coal Mine.

### **Utilizing mining wastes for making bricks, fueling power plant and filling underground cavity due to coal mining**

Now the majority of mining wastes were used as fills for subsided land reclamation, the cost is relative high for agricultural lands compared with their benefits and the value of resources of mining wastes, especially remainder burnable carbon, does not make full use. Therefore, first choice to treat mining wastes is to promote the ratio of utilization of mining wastes for making bricks, fueling power plant and then filling underground cavity due to coal mining to lessen mining subsidence, filling subsided basin to reclaim lands for construction purpose, afforestation purpose and agricultural purpose, and reshaping or tipping mining wastes dump for landscape construction.

### **CONCLUSIONS**

Mining wastes disposal is an important problem for mine environmental protection or construction, into which multi-disciplinary knowledge is involved in accordance with the methods being taken. First of all, the composition of mining wastes, which changes with the geological background is important for utilization of mining wastes and the measures we should take to treat. For acidic mining wastes, lime should be used for neutralizing acidic pollution; for high carbonaceous mining wastes, the first choice for its utilization should be the fuel for power plant. There are different kinds and different uses of mining wastes in Yanzhou coalfield. The first choice to treat mining wastes should be filling subsided lands for construction purpose in terms of consumption amount, and then used for materials of bricks, filling underground cavity, filling subsided basin to reclaim lands for afforestation purpose and agricultural purpose, and reshaping or tipping mining wastes dump for landscape construction.

### **ACKNOWLEDGMENTS**

The investigations were supported by Natural Scientific Fund of China with approved no. 50574095. The investigations were also supported by the 111 project with approved no. B07028, the project for Ph.D. program with approved no. 20060290511, the project for new century talents with approved no. NCET-04-0487 and the project for authors of excellent Ph.D. dissertations with approved no. 200044 hosted by Ministry of Education of China.

### **REFERENCES**

1. Tiwary, R. K., 2001, Environmental impact of coal mining on water regime and its management. *Water, Air, and Soil Pollution*, 132: 185–199.
2. Siboni, N., Fine, M., Bresler, V., Loya, Y., 2004, Coastal coal pollution increases Cd concentrations in the predatory gastropod *Hexaplex trunculus* and is detrimental to its health. *Marine Pollution Bulletin*, 49, 111–118.

3. Janez Oman, Boris Dejanovic, Matija Tuma, 2002, Solutions to the problem of waste deposition at a coal-fired power plant. *Waste Management*, 22, 617–623.
4. Simon Glauser, Mary Louise McAllister and Geraldo Milioli, 2005, The challenges of sustainability in mining regions: The coal mining region of Santa Catarina, Brazil. *Natural Resources Forum*, 29, 1–11.
5. Ali Osman Ylmaz, Tuncay Uslu, 2007, The role of coal in energy production— Consumption and sustainable development of Turkey. *Energy Policy* 35, 1117–1128.
6. David Creedy, Wang Lijie, Zhou Xinquan, Liu Haibin and Gary Campbell, 2006, Transforming China's coal mines: A case history of the Shuangliu Mine. *Natural Resources Forum*, 30, 15–26.
7. Bell F. G., Stacey T. R., Genske D. D., 2000, Mining subsidence and its effect on the environment: some differing examples. *Environmental Geology*, Volume 40, Numbers 1-2, 135-152.
8. Earle A. Ripley, Robert E. Redmann., 1996, *Environmental effects of mining*. CRC Press, 49-85.
9. Matetic R. J., Liu J., and Elsworth D., 1995, Modeling The Effects of Longwall Mining on the Ground Water System. Report of Investigations 9561, United States Bureau Of Mines, 9-13.
10. McCulloch C. M. & Nairn J. P., 1996, Determining the impacts from mining on surface and ground water. *Mining Engineering*, 48(1), 57-60.
11. McKinnon E., 2002, The environmental effects of mining waste disposal at Lihir Gold Mine, Papua New Guinea. *Journal of Rural and Remote Environmental Health*, 1(2), 40-50
12. Bian Zhengfu & Zhang Y., 2006, Land Use Changes in Xuzhou Coal Mining Area. *Acta Geographica Sinica*, 61(4), 349-358 (In Chinese).
13. Caldwell, J. A., Moss, A.S.E., 1981, The Simplified Analysis of Mine Waste Embankments. Symposium on Design of Non-Impounding Mine Waste Embankments. Denver USA. AIME Fall Meeting.
14. Catherine Driussi, Janis Jansz, 2005, Technological options for waste minimization in the mining industry. *Journal of Cleaner Production*, U.S. Congress, Office of Technology Assessment, Managing Industrial Solid Wastes From Manufacturing, Mining, Oil and Gas Production, and Utility Coal Combustion-Background Paper, OTA-BP-O-82 (Washington, DC: U.S. Government Printing Office, February 1992).
15. J.J.M Heynen, H.N.J.A. Bolk, G.J. Senden and P.J. Tummers, 1994, Re-use of colliery spoils in construction materials using Fluidized Bed Combustion. *Environmental Aspects of Construction with Waste Materials*. J.J.J.M. Goumans, H.A. van der Sloot and Th.G. Aalbers (Editors), Elsevier Science B.V. 655-664.
16. Sebastian STEFANIAK, Irena TWARDOWSKA, 2003, geochemically unstable minerals in carboniferous rocks in the light of prognosing the environmental impact of coal mining wastes. *Mineralogical Society of Poland – Special Papers*, Volume 22, 215-217.
17. Topuz, E. et al., 1998, Feasibility of an integrated coal mining and waste disposal system. In: *Environ. Issues Waste Manage. Energy Miner. Prod.. Proc. Int. Symp.. 5th, 1998* (Edited by Pasamehmetoglu A. G. and Ozgenoglu A.), 531-542.

18. J.K. Kwolek, 1999, Aspects of geo-legal mitigation of environmental impact from mining and associated waste in the UK. *Journal of Geochemical Exploration*, 66: 327–332.
19. Grycznanski, M. et al., 1997, Coal mining waste as a structural material in Polish civil and water engineering. In: *Proceedings of International Conference on Solid Waste Technology Management, 1997*, 13, (1), Paper 5A/3, 1-8.
20. Canibano, J. G., 1995, Latest developments in the utilization of coal mining wastes. *Coal Sci. Technol.*, 24 (2), 1629-1632.
21. K. M. Skarzynska, 1995, Reuse of coal mining wastes in civil engineering - part 2: Utilization of minestone. *Waste Management*, 15(2), 83-126.
22. Dongxu Li, Xuyan Song, Chenchen Gong, Zhihua Pan, 2006, Research on cementitious behavior and mechanism of pozzolanic cement with coal gangue. *Cement and Concrete Research*, 36, 1752– 1759.
23. Carolina Martinez-Ruiz, Belen Fernandez-Santos, Philip D. Putwain, Maria Jose Fernandez-Gomez, 2007, Natural and man-induced revegetation on mining wastes: Changes in the floristic composition during early succession. *Ecological Engineering*, 30, 286–294.
24. A. Romero, I. Gonzalez, E. Galan, 2006, Estimation of potential pollution of waste mining dumps at Pena del Hierro (Pyrite Belt, SW Spain) as a base for future mitigation actions. *Applied Geochemistry*, 21, 1093–1108.
25. Maideyi Meck, David Love, Benjamin Mapani, 2006, Zimbabwean mine dumps and their impacts on river water quality – a reconnaissance study. *Physics and Chemistry of the Earth*, 31, 797–803.
26. M.K. Ghose, 2003, Indian small-scale mining with special emphasis on environmental management. *Journal of Cleaner Production* 11, 159–165.
27. Rene Lefebvre, Daryl Hockley, Jason Smolensky, Pierre Gelinas, 2001a, Multiphase transfer processes in waste rock piles producing acid mine drainage 1: Conceptual model and system characterization. *Journal of Contaminant Hydrology*, 52,137–164.
28. Rene Lefebvre, Daryl Hockley, Jason Smolensky, Ann Lamontagne, 2001b, Multiphase transfer processes in waste rock piles producing acid mine drainage 2. Applications of numerical simulation. *Journal of Contaminant Hydrology*, 52,165–186.
29. Hubert Wiggering, 1987, Weathering of clay minerals in waste dumps of Upper Carboniferous coal-bearing strata, the Ruhr area, West Germany. *Applied Clay Science*, 2(4), 353-361.